

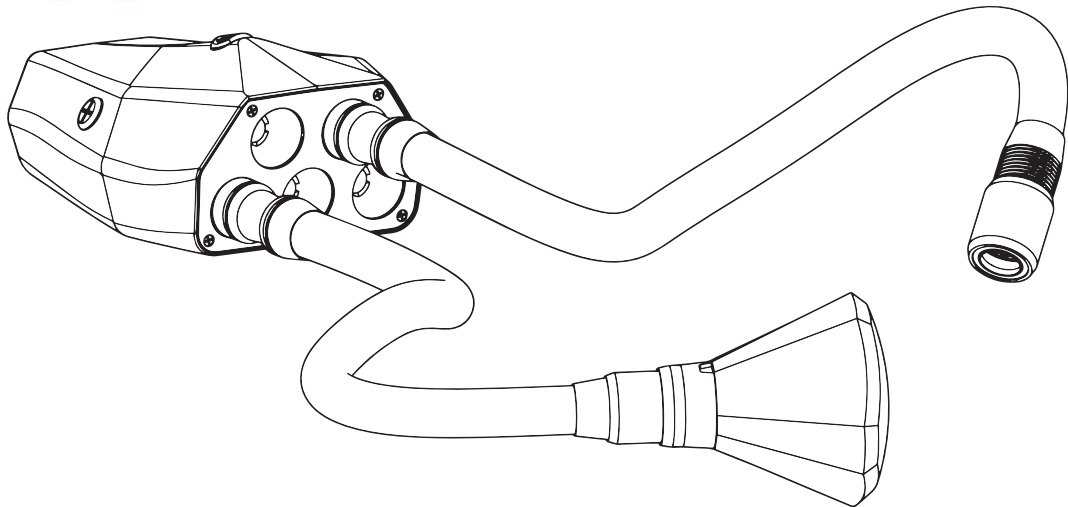

ADAPTALUX

ILLUMINATE. ADAPT. CREATE.



INSTRUCTION MANUAL

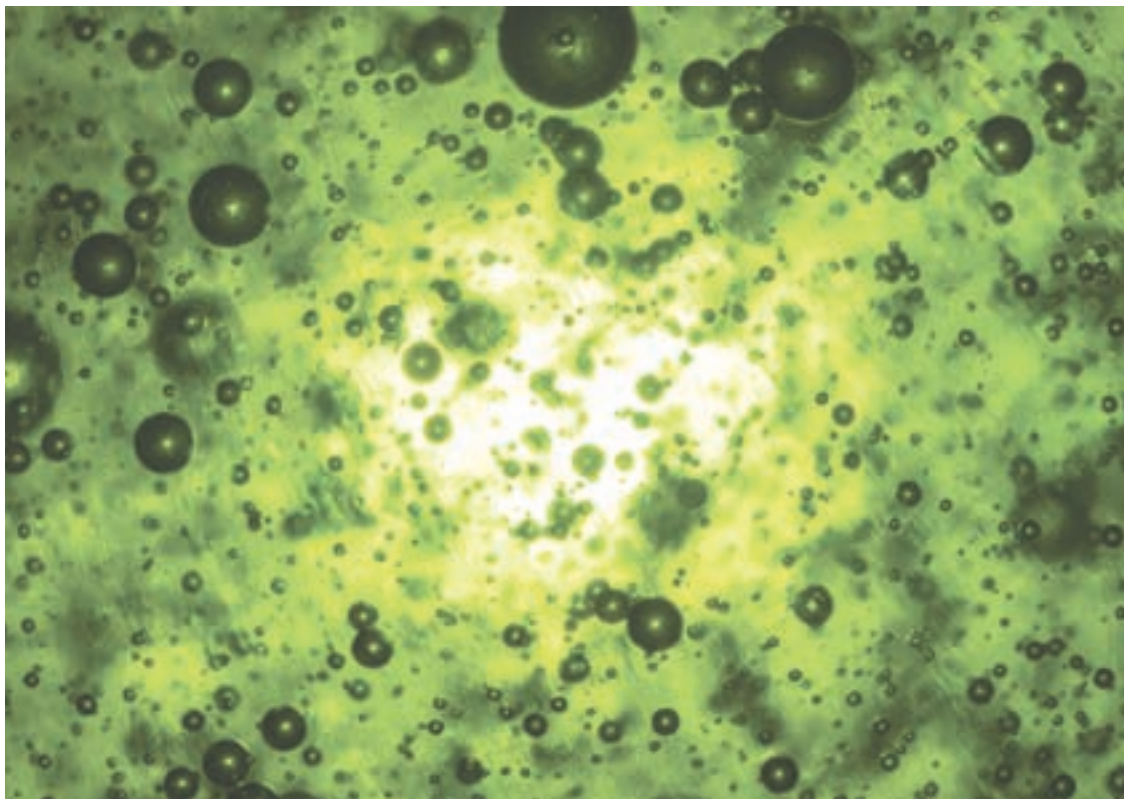



CONTENTS

CONTROL POD

Turning on.....	P1
Turning off.....	P2
Brightness control.....	P3
Memory and sleep.....	P7
Wireless control.....	P9
Battery status.....	P11
Charging.....	P12
Camera mounting.....	P13
Tripod mounting.....	P14

LIGHTING ARMS

Attaching Lighting Arms.....	P15
Light direction.....	P17
Beam angle control.....	P18

DIFFUSERS & COLOUR FILTERS

How to attach/detach.....	P19
---------------------------	-----

CONTROL POD

THE COMMAND CENTRE FOR ADAPTALUX

DISTINCTIVE DESIGN

INTELLIGENT POWER MANAGEMENT

UP TO 12 HOURS BATTERY LIFE

BLUETOOTH COMPATIBLE

NOT RECOMMENDED TO BE USED IN
WET CONDITIONS

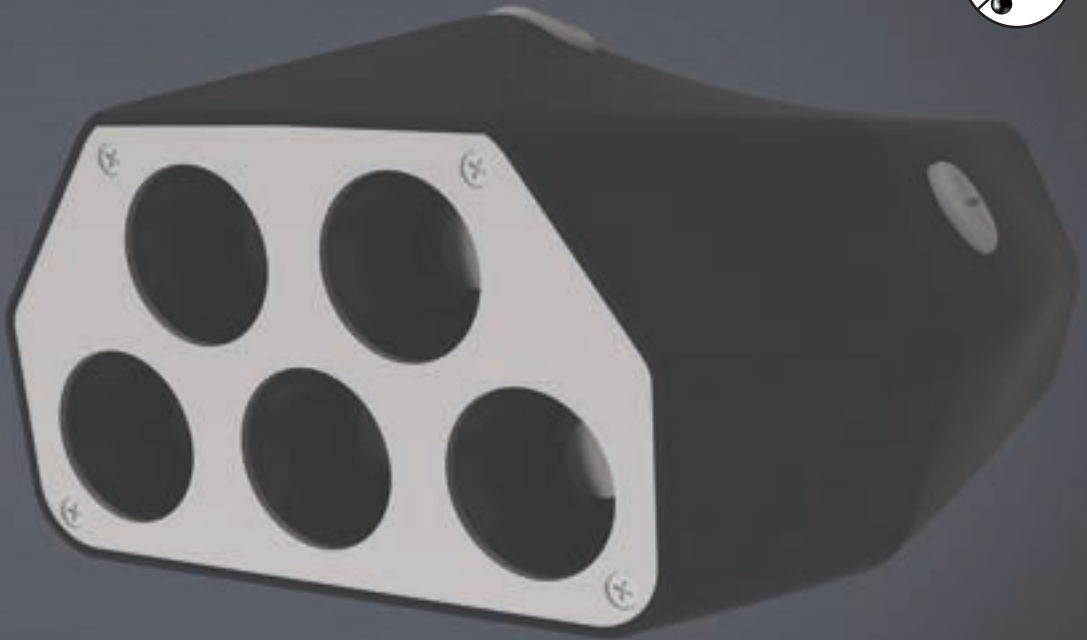

TURNING ON

CONTROL POD
LIGHTING ARMS

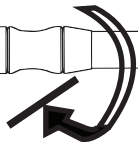
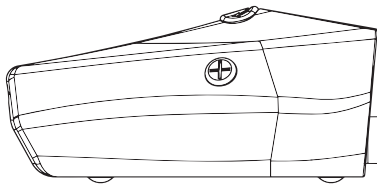
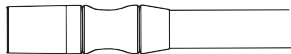
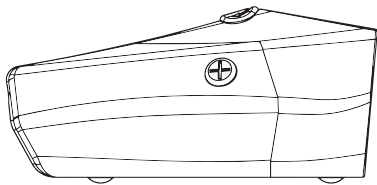
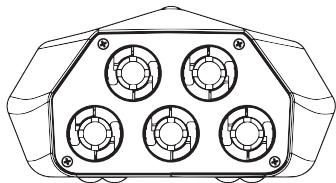

TURNING OFF

CONTROL POD
LIGHTING ARMS

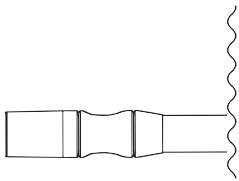
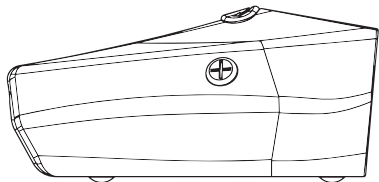

BRIGHTNESS CONTROL

CONTROL POD

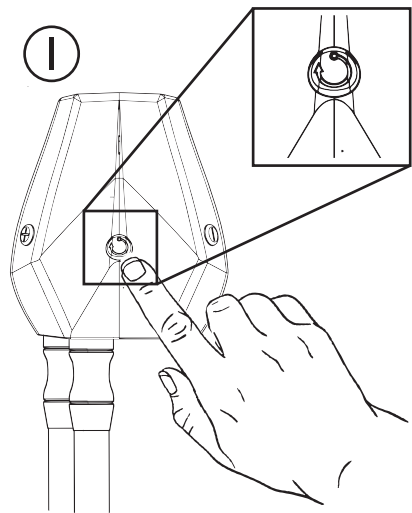

TAP ONCE

3

=

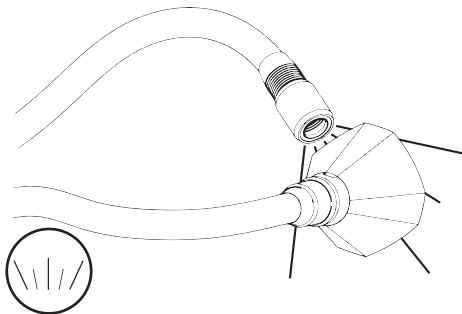

PULSING LIGHTING ARM =
ARM SELECTED



TO ACT

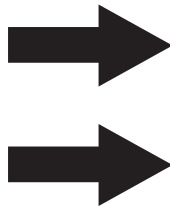

2

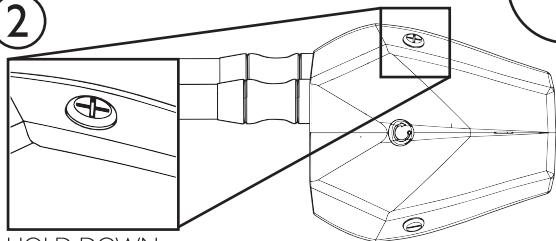

HOLD DOWN
TO ADJUST



LIGHTING ARM FLASHES =
MAXIMUM BRIGHTNESS REACHED

OR

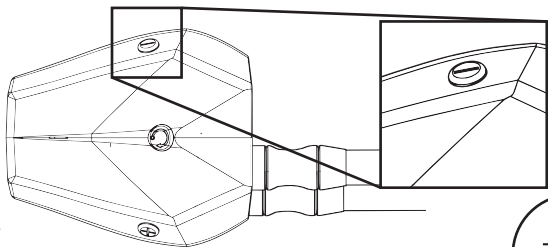

LIGHTING ARM FLASHES =
MINIMUM BRIGHTNESS REACHED

BRIGHTNESS CONTROL

CONTROL POD

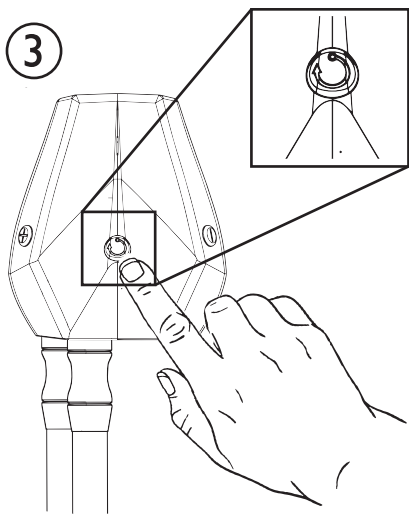

=

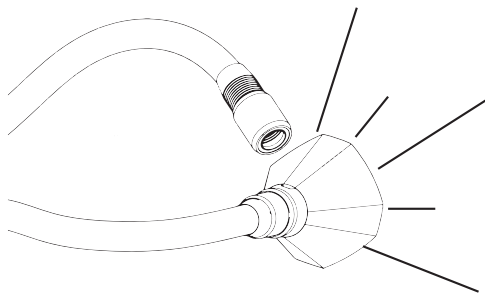

OR

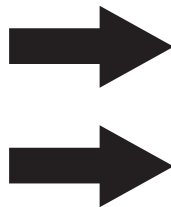

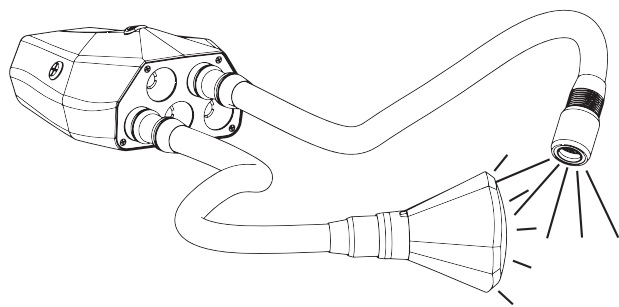
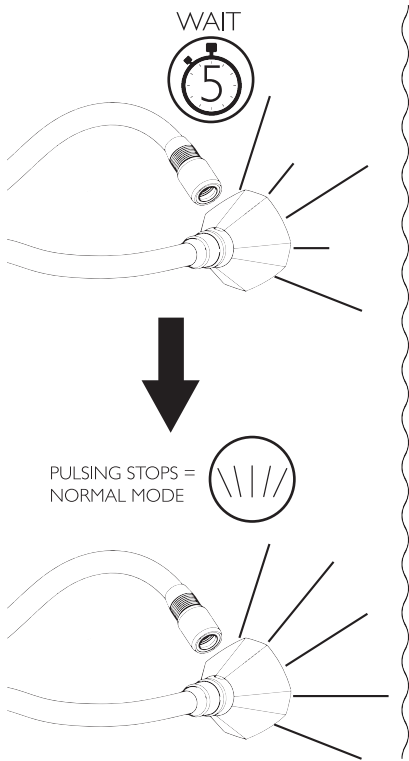

MEMORY & SLEEP

CONTROL POD

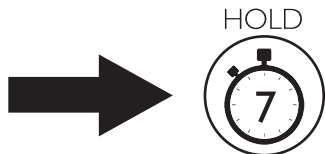
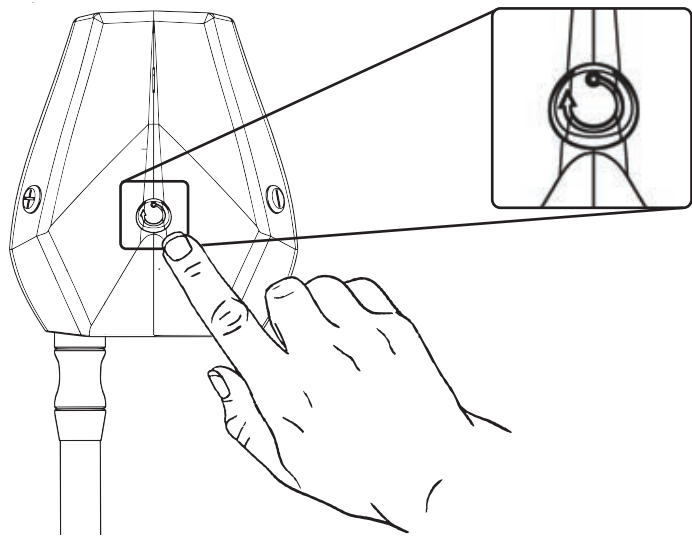

FLASHING
GREEN

TAP ONCE

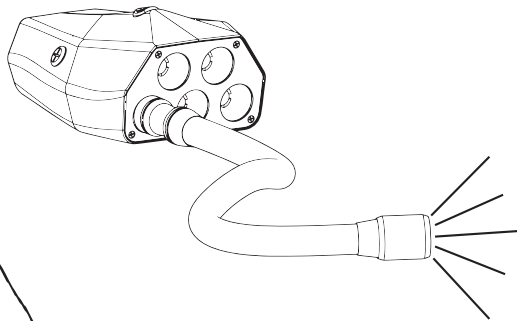
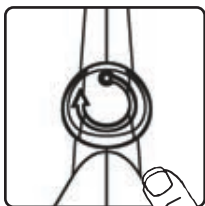

TURN ON WIRELESS

CONTROL POD

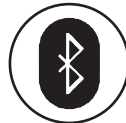
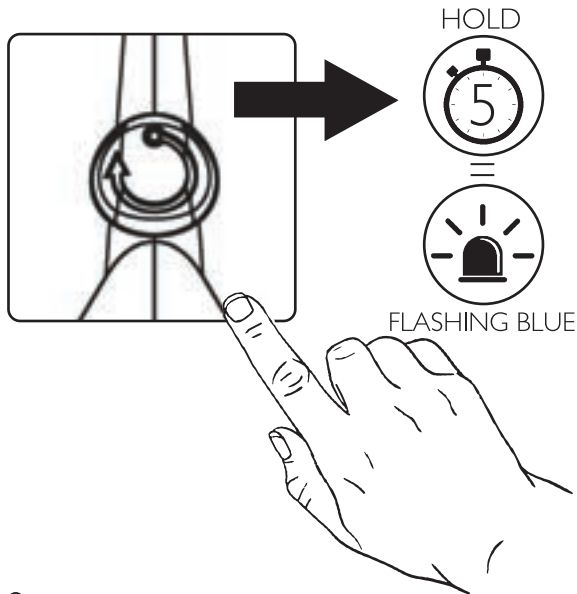

SOLID BLUE



TURN OFF WIRELESS

CONTROL POD

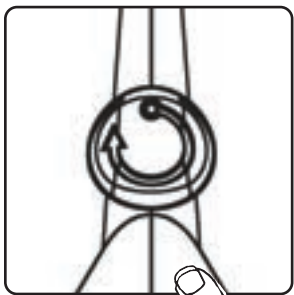

HOLD



PULSE

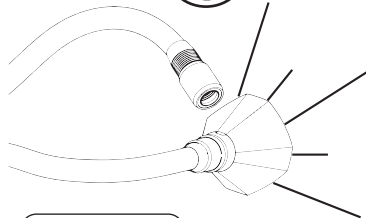

BATTERY STATUS

CONTROL POD

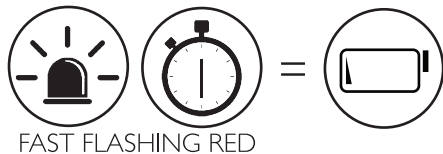
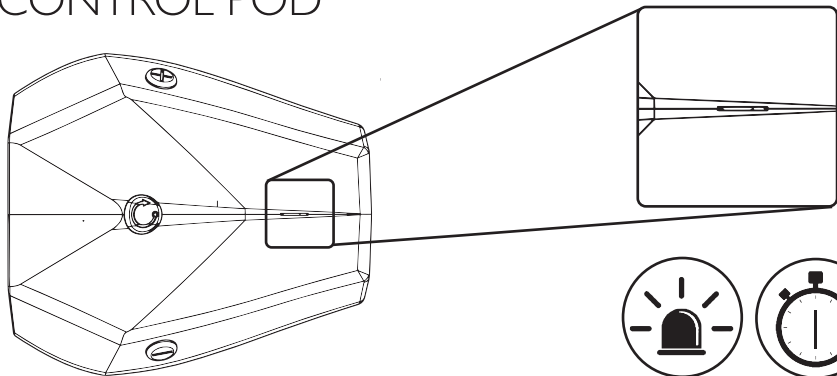

FAST FLASHING RED

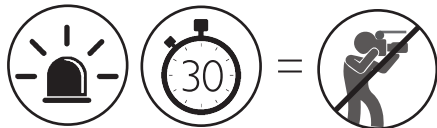

SLOW FLASHING RED



RAPID
FLASHING
RED

CHARGING

CONTROL POD

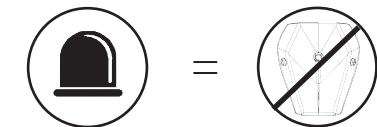

SOLID AMBER



MINUTES

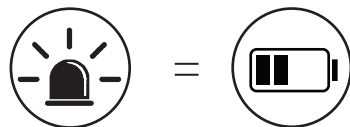

FLASHING RED

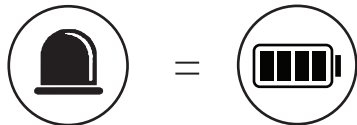

SOLID RED

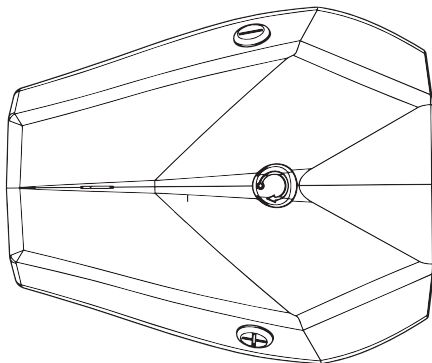
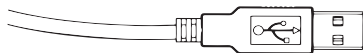

CAMERA MOUNTING

CONTROL POD

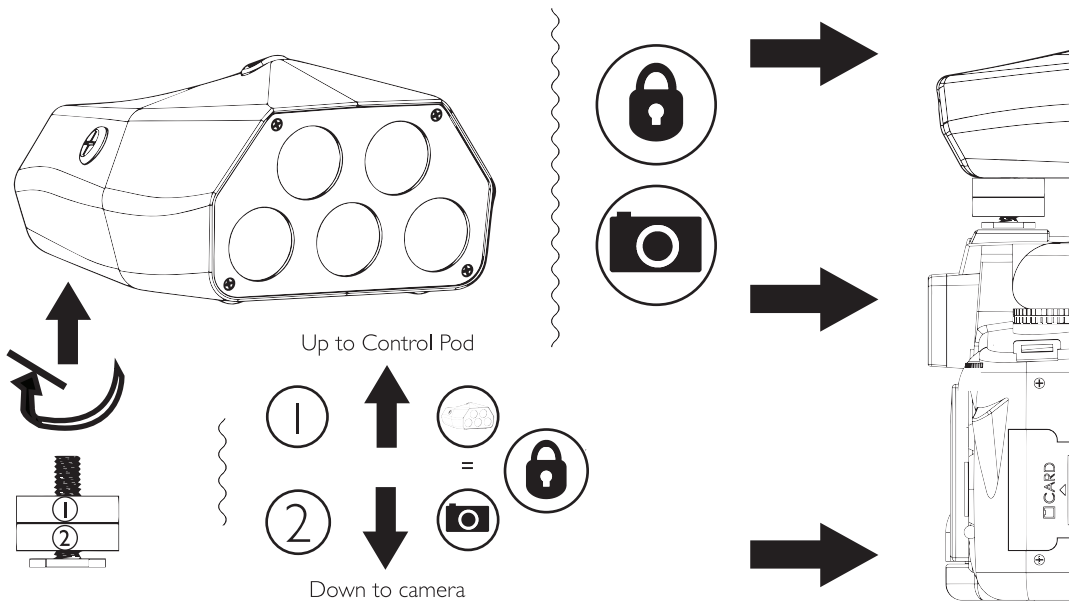

TRIPOD MOUNTING

CONTROL POD

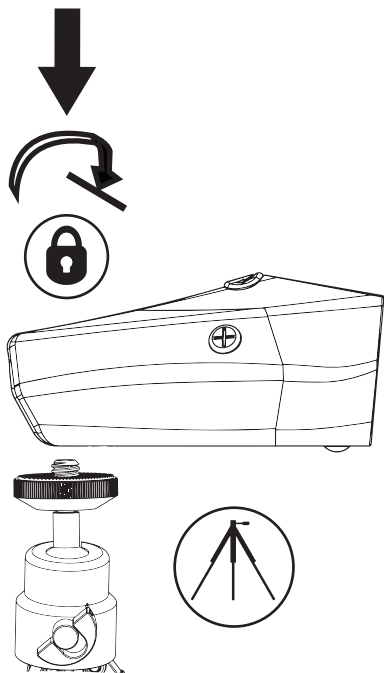
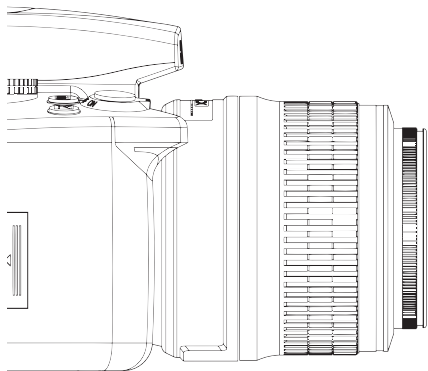
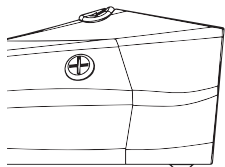

LIGHTING ARMS



A DYNAMIC LIGHT SOURCE

A VARIETY OF COLOURS

UP TO 210 LUMENS

FULLY FLEXIBLE

FULL BEAM CONTROL

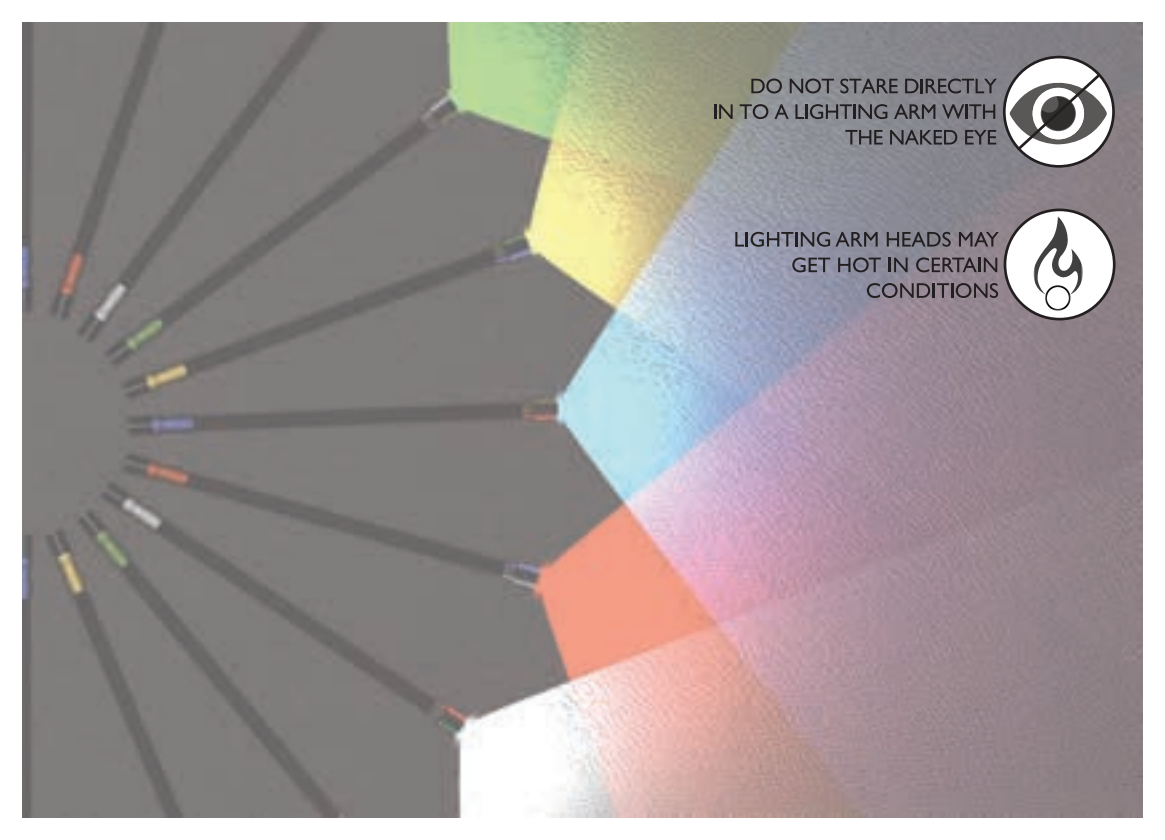
A fan of lighting arms radiating from a central point on the left. Each arm has a different colored head: green, yellow, light blue, pink, orange, and white. The background is a dark grey gradient.

DO NOT STARE DIRECTLY
IN TO A LIGHTING ARM WITH
THE NAKED EYE



LIGHTING ARM HEADS MAY
GET HOT IN CERTAIN
CONDITIONS



ATTACHING

LIGHTING ARMS

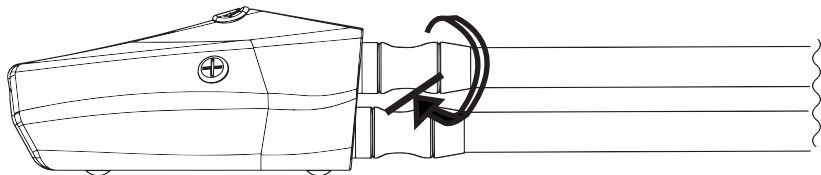
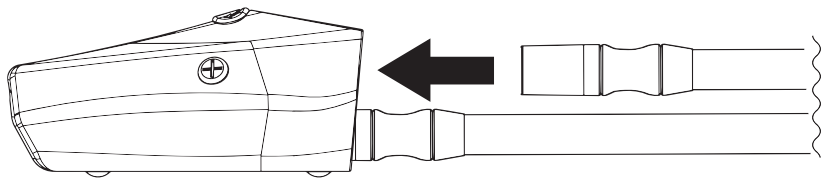

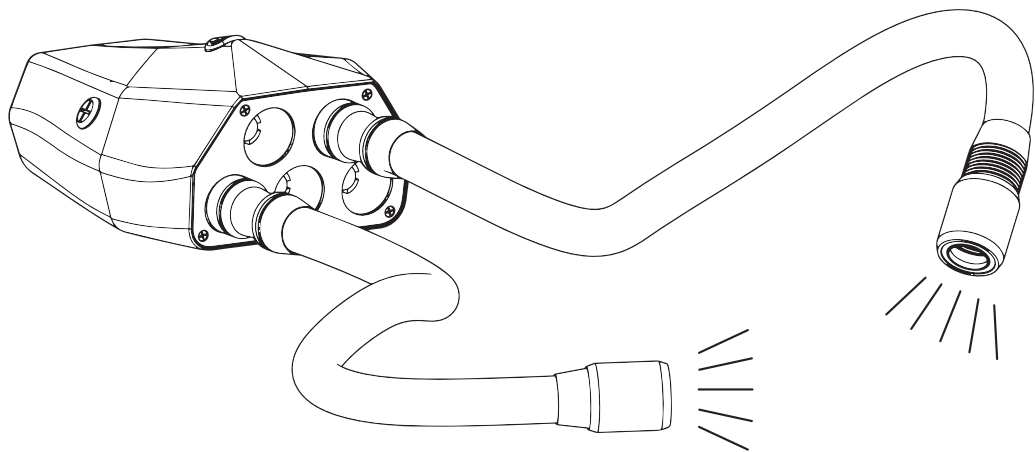

LIGHT DIRECTION

LIGHTING ARMS

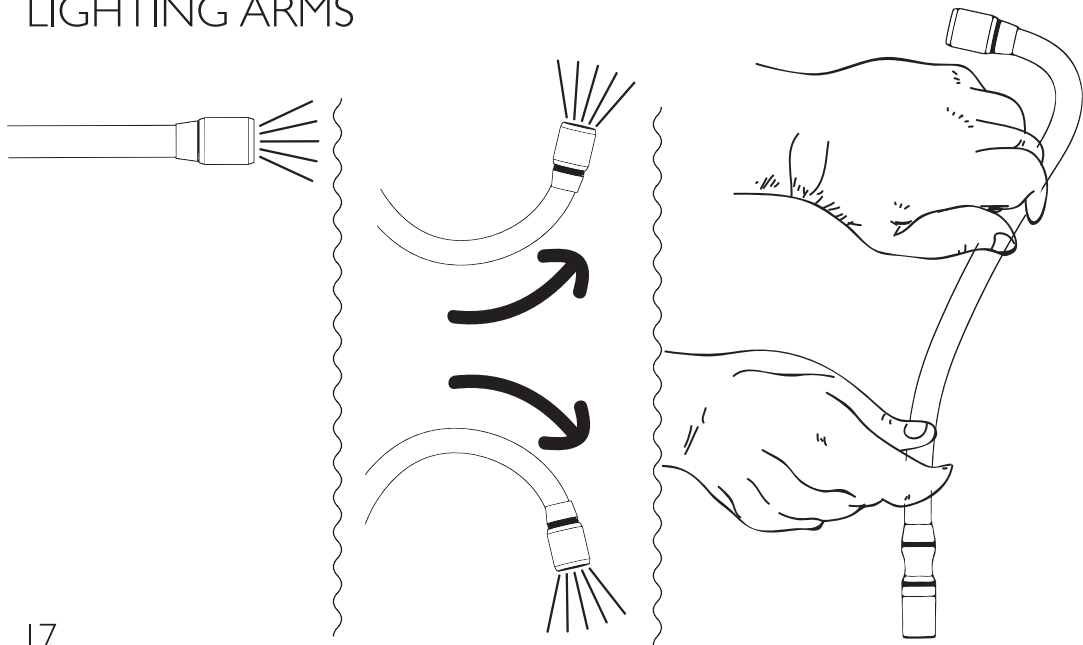

BEAM ANGLE CONTROL

LIGHTING ARMS

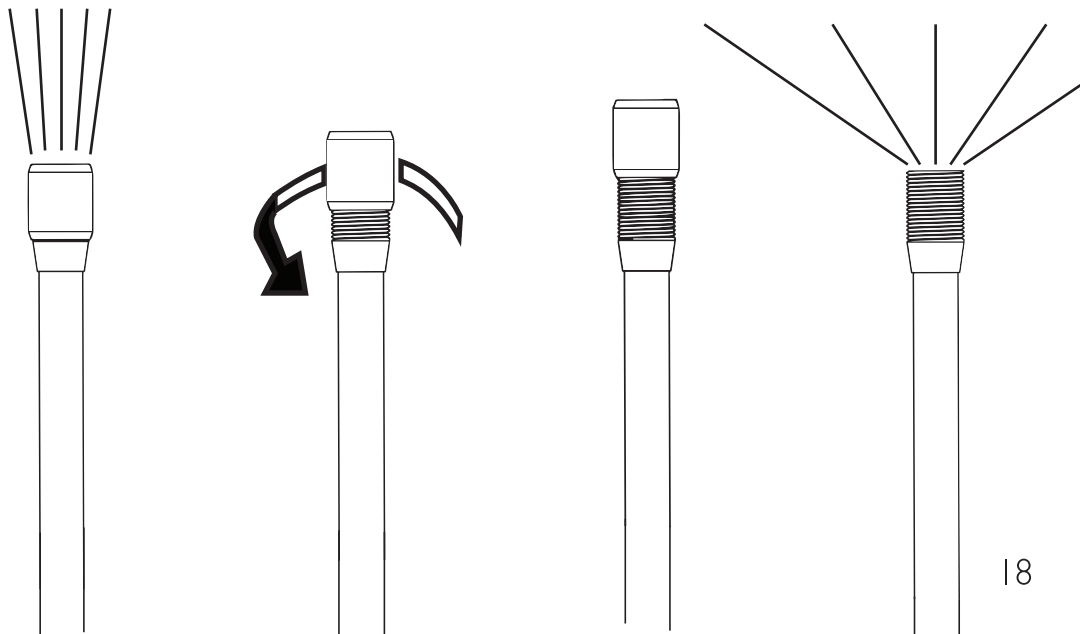

COLOUR FILTERS & DIFFUSERS



EASY TO USE

VARIETY OF EFFECTS



ATTACH/DETACH

COLOUR FILTERS & DIFFUSERS

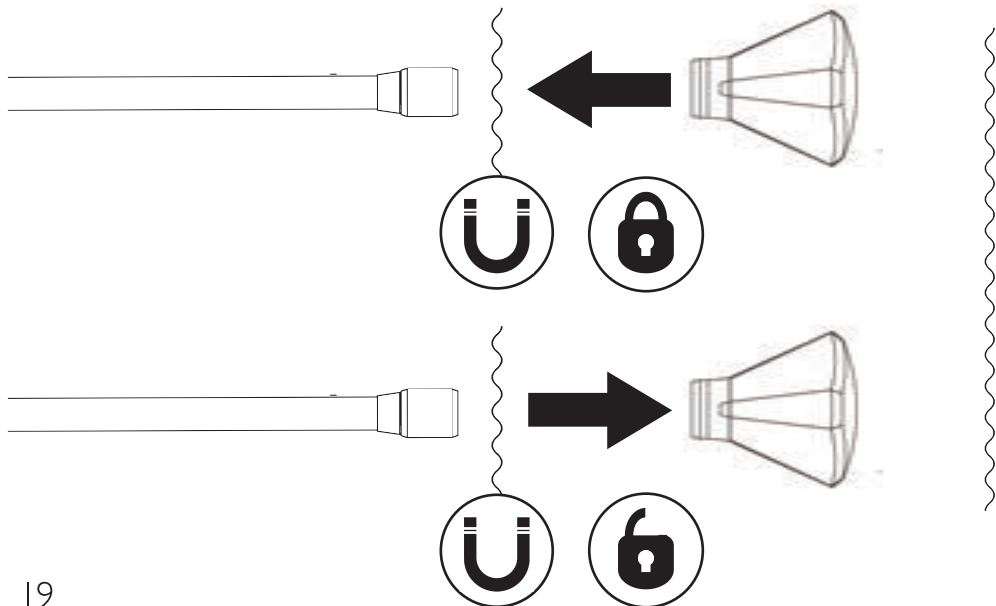

FOR OTHER LANGUAGES & HELP, PLEASE VISIT
WWW.ADAPTALUX.COM/HELP

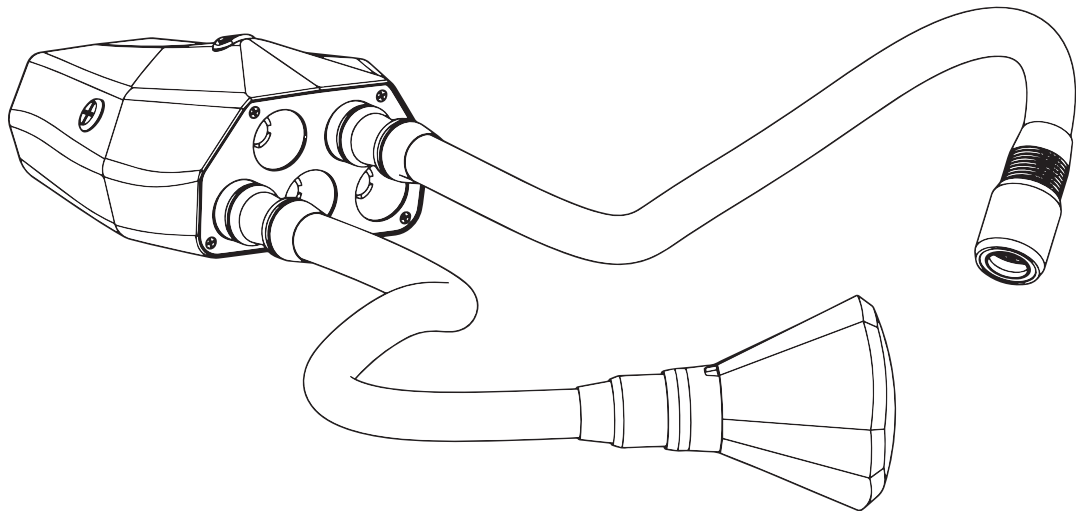







DESIGNED BY ADAPTALUX IN THE UK.
PRINTED IN THE UK.